



Do wody czystej
(Maksymalna zawartość piasku 100 g/m³)



Budownictwo



Rolnictwo



Przemysł



DANE WYDAJNOŚCIOWE

- Wydajność do **1500 l/min** (90 m³/h)
- Wysokość podnoszenia **375 m**

DANE TECHNICZNE

- Maksymalna temperatura wody **+35 °C**
- Maksymalna zawartość piasku **100 g/m³**
- Maksymalna głębokość zanurzenia **200 m**
- Możliwość podłączenia:
 - pionowa
 - pozioma, z następującymi ograniczeniami:
 - 6HR34 do **11 stopni**
 - 6HR44 do **10 stopni**
 - 6HR54 do **9 stopni**
 - 6HR64 do **7 stopni**
- Ilość załączeń silnika na godzinę: 20 w regularnych odstępach czasu
- Minimalna wydajność dla chłodzenia silnika **10 cm/s**
- Tryb pracy silnika - Praca ciągła S1

KONSTRUKCJA I STANDARDY BEZPIECZEŃSTWA

SILNIK ELEKTRYCZNY

– Trójfazowy 400 V - 50 Hz

4 m długość kabla zasilającego

EN 60335-1
IEC 60335-1
CEI 61-150

EN 60034-1
IEC 60034-1
CEI 2-3



EU REGULATION Nr 547/2012

CERTYFIKATY, KONSTRUKCJA I STANDARDY BEZPIECZEŃSTWA

Firma zarządzana certyfikatem DNV
ISO 9001: QUALITY



ZASTOSOWANIE

Nadaje się do stosowania z czystą wodą o zawartości piasku nie większej niż 100 g / m³. Ze względu na swoją wysoką wydajność i niezawodność nadają się do zastosowania w zastosowaniach cywilnych, rolniczych i przemysłowych, takich jak dystrybucja wody w połączeniu ze zbiornikami ciśnieniowymi, do nawadniania i podnoszenia ciśnienia w zestawach przeciwpożarowych itp.

PATENTY

Wzór zastrzeżony nr 004675106-0002

OPCJE DOSTĘPNE NA ŻĄDANIE

- 6HR-HYD Pompy wyposażone w podwójną obudowę do zasilania 400/690 V (gwiazda/trójkąt)
- Inne napięcia i częstotliwość 60 Hz

CHARAKTERYSTYKA POMP

50 Hz n = 2900 min⁻¹

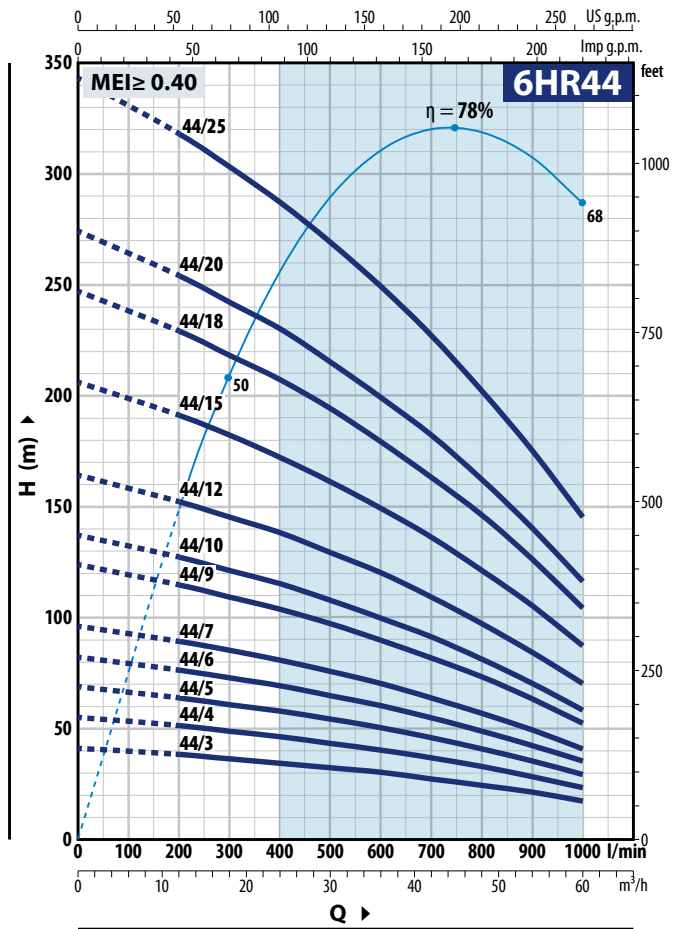
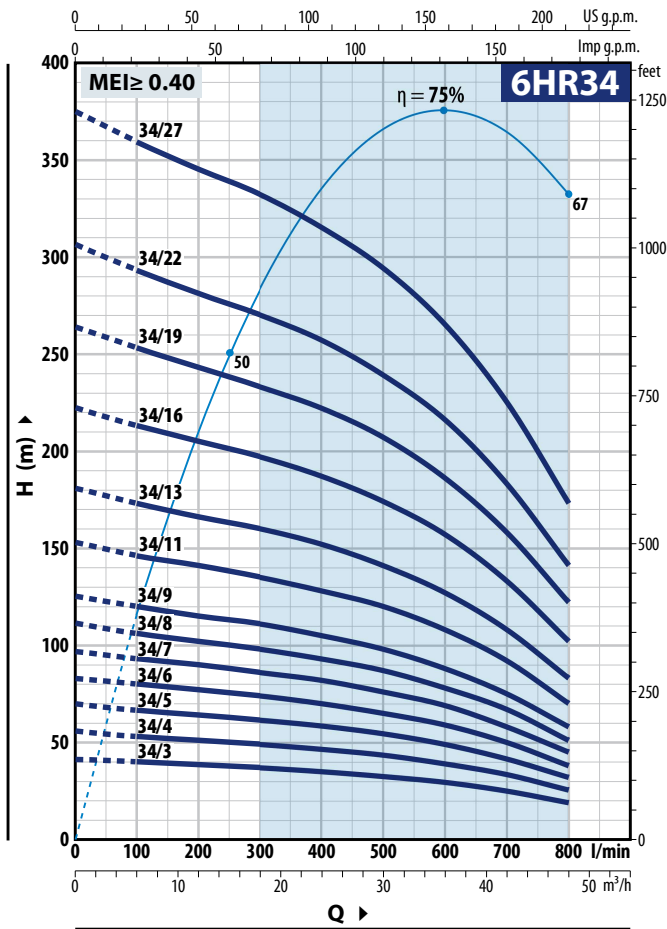

6HR34

MODEL	MOC (P ₂)		Q	m ³ /h											
	kW	HP		0	6	12	18	24	30	36	42	48			
Trójfazowa			l/min	0	100	200	300	400	500	600	700	800			
6HR 34/3	4	5.5	H metry	41.5	40	38.5	37	35	32.5	29.5	25	19			
6HR 34/4	5.5	7.5		55.5	53	51	49	46.5	43.5	39	33.5	25.5			
6HR 34/5	7.5	10		69.5	66.5	64	61.5	58.5	54.5	49	41.5	32			
6HR 34/6	9.2	12.5		83	80	77	74	70	65	59	50	38			
6HR 34/7	11	15		97	93	90	86	82	76	69	58	45			
6HR 34/8	11	15		111	106	102	98	93	87	78	67	51			
6HR 34/9	13	17.5 ⁽¹⁾		125	120	115	111	105	98	88	75	58			
6HR 34/11	15	20		153	146	141	135	128	120	108	92	70			
6HR 34/13	18.5	25		181	173	166	160	152	141	127	108	83			
6HR 34/16	22	30		222	213	205	197	187	174	157	133	102			
6HR 34/19	26	35 ⁽²⁾		264	253	243	233	222	207	186	158	122			
6HR 34/22	30	40		306	293	281	270	257	239	216	183	141			
6HR 34/27	37	50		375	359	345	332	315	294	265	225	173			

6HR44

MODEL	MOC (P ₂)		Q	m ³ /h											
	kW	HP		0	12	18	24	30	36	42	48	54	60		
Trójfazowa			l/min	0	200	300	400	500	600	700	800	900	1000		
6HR 44/3	5.5	7.5	H metry	41	38	36	34	32	30	27	24	21	17		
6HR 44/4	7.5	10		55	51	48.5	46	43	40	36.5	32.5	28	23		
6HR 44/5	7.5	10		68.5	63.5	60.5	57.5	54	50	45.5	40.5	35	29		
6HR 44/6	9.2	12.5		82	76	72.5	69	64.5	60	54.5	48.5	42	35		
6HR 44/7	11	15		96	89	85	80.5	75.5	70	63.5	56.5	49	40.5		
6HR 44/9	13	17.5 ⁽¹⁾		123.5	114.5	109	103.5	97	89.5	81.5	73	63	52		
6HR 44/10	15	20		137	127	121	115	107.5	99.5	91	81	70	58		
6HR 44/12	18.5	25		164	152	145	138	129	120	109	97	84	70		
6HR 44/15	22	30		206	191	182	172	161	149	136	121	105	87		
6HR 44/18	26	35 ⁽²⁾		247	229	218	207	194	179	163	146	126	104		
6HR 44/20	30	40		274	254	242	230	215	199	182	162	140	116		
6HR 44/25	37	50		343	318	303	287	269	249	227	202	175	145		

Q = Wydajność H = Wysokość podnoszenia
 (1) Pompa wyposażona w silnik o mocy 20 KM
 (2) Pompa wyposażona w silnik o mocy 40 KM

Tolerancja charakterystyk wg EN ISO 9906 Grade 3B.

CHARAKTERYSTYKA POMP

50 Hz n = 2900 min⁻¹

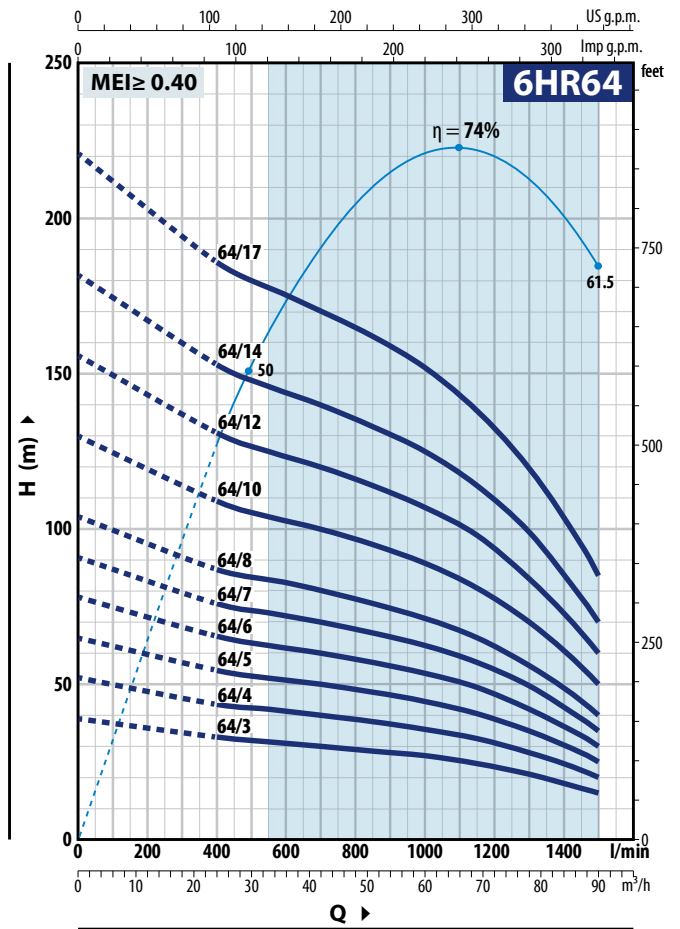
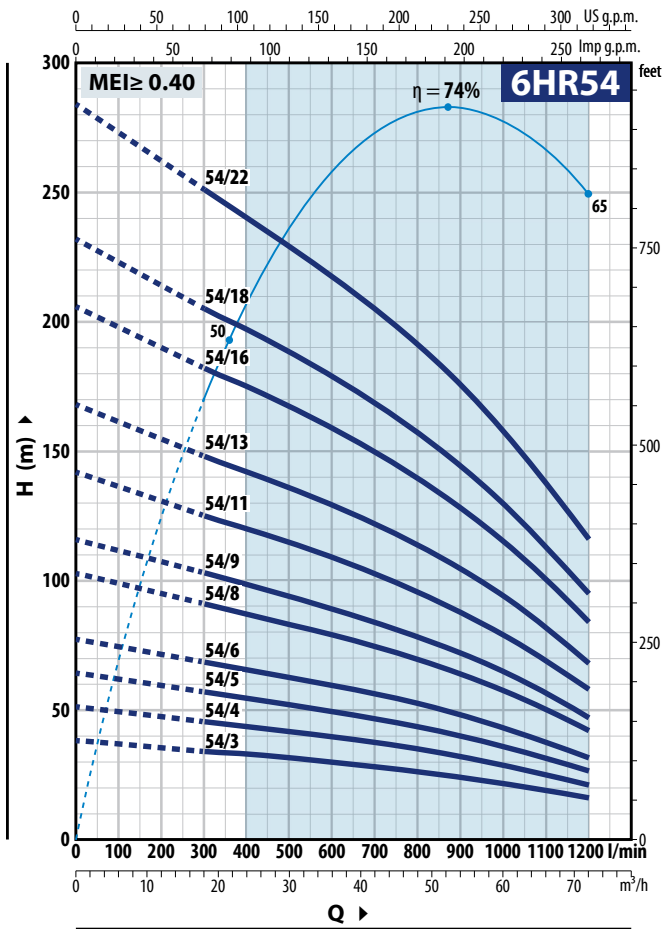

6HR54

MODEL	MOC (P ₂)		Q	m ³ /h												
	kW	HP		0	18	24	30	36	42	48	54	60	66	72		
Trójfazowa			l/min	0	300	400	500	600	700	800	900	1000	1100	1200		
6HR 54/3	5.5	7.5	H metry	38.5	34	33	31.5	29.5	28	26	24	21.5	19	16		
6HR 54/4	7.5	10		51.5	45.5	43.5	41.5	39.5	37.5	35	32	29	25	21		
6HR 54/5	9.2	12.5		64.5	57	54.5	52	49.5	46.5	43.5	40	36	31.5	26.5		
6HR 54/6	11	15		77.5	68.5	65.5	62.5	59.5	56	52.5	48	43	37.5	31.5		
6HR 54/8	13	17.5 ⁽¹⁾		103	91	87	83	79	74.5	69.5	64	57.5	50.5	42		
6HR 54/9	15	20		116	103	98	94	89	84	78	72	65	57	47		
6HR 54/11	18.5	25		142	125	120	115	109	103	96	88	79	69	58		
6HR 54/13	22	30		168	148	142	136	129	121	113	104	94	82	68		
6HR 54/16	26	35 ⁽²⁾		206	182	175	167	159	149	139	128	115	101	84		
6HR 54/18	30	40		232	205	197	188	178	168	157	144	130	113	95		
6HR 54/22	37	50		284	251	240	229	218	205	192	176	158	138	116		

6HR64

MODEL	MOC (P ₂)		Q	m ³ /h										
	kW	HP		0	24	33	42	51	60	69	78	87	90	
Trójfazowa			l/min	0	400	550	700	850	1000	1150	1300	1450	1500	
6HR 64/3	7.5	10	H metry	39	33	31.5	30	28.5	27	24.5	21	16.5	15	
6HR 64/4	9.2	12.5		52	43.5	42	40	38	35.5	32.5	28	22.5	20	
6HR 64/5	11	15		65	54.5	52	50	47.5	44.5	40.5	35	28	25	
6HR 64/6	13	17.5 ⁽¹⁾		78	65.5	62.5	60	57	53.5	49	42	33.5	30	
6HR 64/7	15	20		91	76	73	70	66.5	62.5	57	49.5	39	35	
6HR 64/8	18.5	25		104	87	84	80	76	71	65	56	45	40	
6HR 64/10	22	30		130	109	104	100	95	89	81	70	56	50	
6HR 64/12	26	35 ⁽²⁾		156	131	125	120	114	107	98	84	67	60	
6HR 64/14	30	40		182	153	146	140	133	125	114	99	78	70	
6HR 64/17	37	50		221	186	178	170	162	152	138	120	95	85	

Q = Wydajność H = Wysokość podnoszenia
 (1) Pompa wyposażona w silnik o mocy 20 KM
 (2) Pompa wyposażona w silnik o mocy 40 KM

Tolerancja charakterystyk wg EN ISO 9906 Grade 3B.

POZ. ELEMENT

DANE KONSTRUKCYJNE

1	GŁOWICA POMPY	Precyzyjnie odlew stali nierdzewnej AISI 304 w komplecie z gwintowanym króćcem przyłączeniowym zgodnie z ISO 228/1
2	ZAWÓR ZWROTNY	Stal nierdzewna AISI 304
3	WSPORNIK SILNIKA	Odlew precyzyjny ze stali nierdzewnej AISI 304 i zgodne ze standardami NEMA
4	WIRNIKI	Odlew precyzyjny stali nierdzewnej AISI 304
5	DYFUZORY	Odlew precyzyjny stali nierdzewnej AISI 304
6	WAŁ POMPY	Stal nierdzewna AISI 304
7	ŁÓŻYSKA POMPY	Elastomer
8	PIERŚCIENIE DOSZCZELNIAJĄCE	Elastomer
9	ZŁĄCZKA SILNIKA	Stal nierdzewna AISI 304
10	FILTR	Stal nierdzewna AISI 304
11	OBUDOWA KABLA	Stal nierdzewna AISI 304
12	MOTOR 6"	6PD = "PEDROLLO" wypełniony olejem

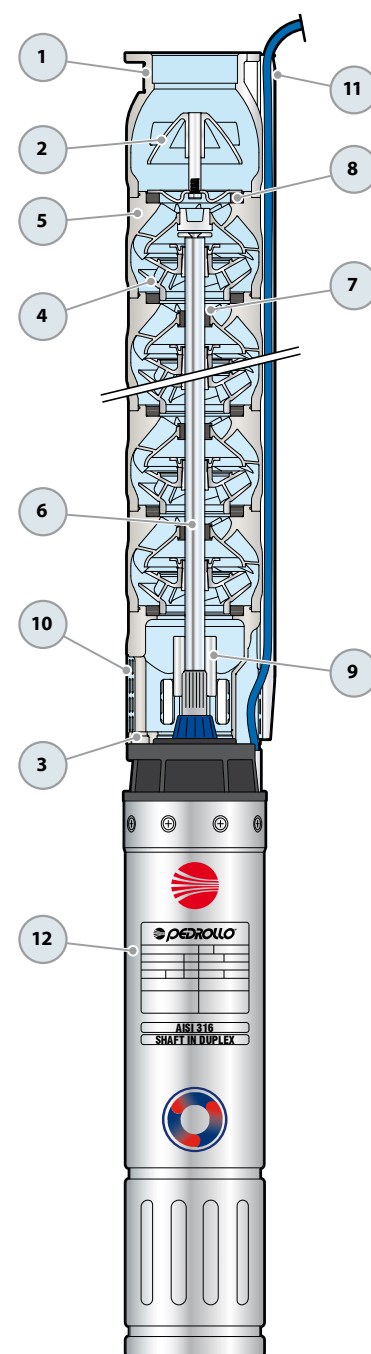

WYMIARY I WAGA

MODEL	KRÓCEC DN	Ø	WYMIARY mm			kg 3~
			h1	h2	h3	
6HR 34/3 - PD	3"	150	581	595	1176	55.4
6HR 34/4 - PD			682	625	1307	61.1
6HR 34/5 - PD			783	660	1443	67.5
6HR 34/6 - PD			884	700	1584	72.9
6HR 34/7 - PD			985	765	1750	83.2
6HR 34/8 - PD			1086	765	1851	86.6
6HR 34/9 - PD			1187	820	2007	98.0
6HR 34/11 - PD			1389	820	2209	105.7
6HR 34/13 - PD			1591	883	2474	122.4
6HR 34/16 - PD			1894	953	2847	138.5
6HR 34/19 - PD			2197	1098	3295	166.6
6HR 34/22 - PD			2500	1098	3598	176.7
6HR 34/27 - PD			3005	1233	4238	203.5
6HR 44/3 - PD			581	625	1206	57.4
6HR 44/4 - PD			682	660	1342	64.1
6HR 44/5 - PD			783	660	1443	67.5
6HR 44/6 - PD			884	700	1584	72.9
6HR 44/7 - PD			985	765	1750	83.2
6HR 44/9 - PD			1187	820	2007	98.0
6HR 44/10 - PD			1288	820	2108	102.3
6HR 44/12 - PD			1490	883	2373	119.0
6HR 44/15 - PD			1793	953	2746	135.1
6HR 44/18 - PD			2096	1098	3194	163.2
6HR 44/20 - PD			2298	1098	3396	169.9
6HR 44/25 - PD			2803	1233	4036	196.8
6HR 54/3 - PD			599	625	1224	57.5
6HR 54/4 - PD			706	660	1366	64.3
6HR 54/5 - PD			813	700	1513	69.7
6HR 54/6 - PD			920	765	1685	80.2
6HR 54/8 - PD			1134	820	1954	95.0
6HR 54/9 - PD			1241	820	2061	99.4
6HR 54/11 - PD			1455	883	2338	116.2
6HR 54/13 - PD			1669	953	2622	129.1
6HR 54/16 - PD	1990	1098	3088	156.3		
6HR 54/18 - PD	2204	1098	3302	164.1		
6HR 54/22 - PD	2632	1233	3865	187.8		
6HR 64/3 - PD	599	660	1259	57.2		
6HR 64/4 - PD	706	700	1406	63.9		
6HR 64/5 - PD	813	765	1578	69.2		
6HR 64/6 - PD	920	820	1740	79.6		
6HR 64/7 - PD	1027	820	1847	90.9		
6HR 64/8 - PD	1134	883	2017	94.2		
6HR 64/10 - PD	1348	953	2301	111.8		
6HR 64/12 - PD	1562	1098	2660	124.4		
6HR 64/14 - PD	1776	1098	2874	147.1		
6HR 64/17 - PD	2097	1233	3330	159.0		

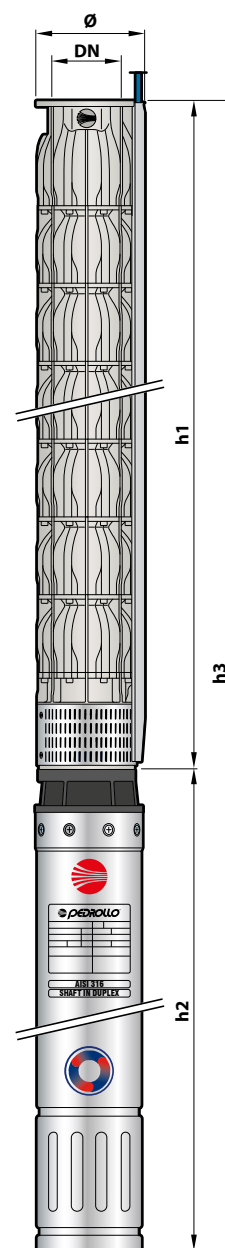

ZESTAW PRZECIWFLANSZY (ZAMAWIANY ODDZIELNIE)

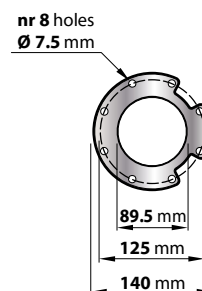

Zestaw składający się z:
przeciwkołnierza, uszczelki, śruby i nakrętki

WYMIARY I WAGA (Tylko część hydrauliczna)

MODEL Pompa	KRÓCEC DN	WYMIARY mm		kg 3~		
		Ø	h1			
6HR 34/3 - HYD	3"	150	581	21.8		
6HR 34/4 - HYD			682	25.1		
6HR 34/5 - HYD			783	28.5		
6HR 34/6 - HYD			884	32.5		
6HR 34/7 - HYD			985	35.8		
6HR 34/8 - HYD			1086	39.2		
6HR 34/9 - HYD			1187	42.6		
6HR 34/11 - HYD			1389	49.7		
6HR 34/13 - HYD			1591	56.4		
6HR 34/16 - HYD			1894	69.5		
6HR 34/19 - HYD			2197	80.6		
6HR 34/22 - HYD			2500	90.7		
6HR 34/27 - HYD			3005	108.5		
6HR 44/3 - HYD					581	21.8
6HR 44/4 - HYD					682	25.1
6HR 44/5 - HYD					783	28.5
6HR 44/6 - HYD					884	32.5
6HR 44/7 - HYD					985	35.8
6HR 44/9 - HYD					1187	42.6
6HR 44/10 - HYD					1288	46.3
6HR 44/12 - HYD					1490	53.0
6HR 44/15 - HYD					1793	66.1
6HR 44/18 - HYD					2096	77.2
6HR 44/20 - HYD					2298	83.9
6HR 44/25 - HYD					2803	101.8
6HR 54/3 - HYD					599	21.9
6HR 54/4 - HYD					706	25.3
6HR 54/5 - HYD					813	28.7
6HR 54/6 - HYD					920	32.8
6HR 54/8 - HYD					1134	39.6
6HR 54/9 - HYD					1241	43.0
6HR 54/11 - HYD					1455	50.2
6HR 54/13 - HYD					1669	57.1
6HR 54/16 - HYD					1990	70.3
6HR 54/18 - HYD					2204	78.1
6HR 54/22 - HYD					2632	92.8
6HR 64/3 - HYD			599	21.6		
6HR 64/4 - HYD			706	24.9		
6HR 64/5 - HYD			813	28.2		
6HR 64/6 - HYD			920	32.2		
6HR 64/7 - HYD			1027	35.5		
6HR 64/8 - HYD			1134	38.8		
6HR 64/10 - HYD			1348	45.8		
6HR 64/12 - HYD			1562	52.4		
6HR 64/14 - HYD			1776	62.1		
6HR 64/17 - HYD			2097	73.0		

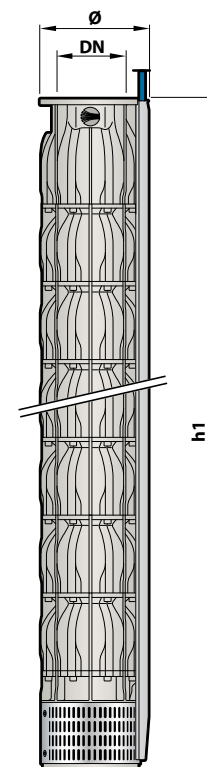

ZESTAW PRZECIWFLANSZY (ZAMAWIANY ODDZIELNIE)

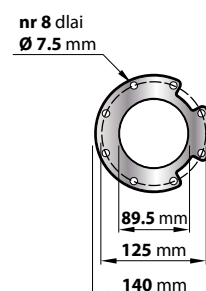

Zestaw składający się z:
przeciwołnier, uszczelka, śruby i nakrętki